

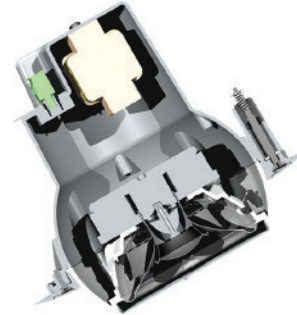

CMS401 DCe

TANNOY®



Product Description

The Tannoy CMS401 DCe is a full bandwidth ceiling monitor system suited to high-level music and speech reinforcement applications requiring exceptional sonic quality with uncompromised reliability.

The CMS401 DCe features Tannoy's exclusive point source Dual Concentric™ driver. The mid-bass and tweeter sections are coincidentally aligned to a true point source; ensuring a wide and controlled dispersion for optimum coverage; this while avoiding the massive loss of energy, in the vertical plane at the crossover frequency, inherent in two-way discrete designs.

This point source, constant directivity drive unit comprises a 100mm (4.00") multi fibre paper pulp mid bass cone and a 19mm (0.75") ferrofluid cooled, titanium dome HF unit with neodymium magnet system. The WideBand™ high frequency unit in the Dual ensures that this drive unit delivers an exceptionally detailed and open sound stage for unrivalled intelligibility. Extending the bandwidth gives percussive sounds more reality and impact, with vocals and instruments clearly more separate and distinct. This design, with extended frequency response and very low distortion, is equipped with dynamic high frequency protection.

The driver and passive frequency-dividing network are mounted in an injection-moulded pod. This, like the ceiling mounting ring in which the pod can be swivelled, is manufactured from UV/weather resistant UL94V-0 ABS material.

The inclusion of a premium quality Tannoy THP 30 multi-tap transformer, for distributed-line operation, provides high system sensitivity, wide bandwidth and dynamic range; achieved with very low insertion loss.

Specifically designed for fast, simple and cost effective installation in new and existing buildings, the CMS401 DCe can be entirely angled towards the listener within the fixed ceiling-mounting ring. The challenge of difficult speaker placement, in less than perfect room configurations, is therefore eliminated by being able to discreetly pivot the loudspeaker towards the desired area of coverage.

Features

- 100mm (4.00") point source Dual Concentric™ driver
- High power & high sensitivity with extended frequency response and very low distortion
- Wide, controlled constant directivity dispersion for optimum coverage
- Does not suffer from massive loss of energy in the vertical plane at crossover caused by two way discrete designs
- UV/weather resistant UL94V-0 ABS construction for structural integrity
- Dynamic high frequency protection
- Low insertion loss 30 Watt line transformer - for a more powerful and dynamic performance
- Tapping switch for settings
- 3 clamp self-aligning mounting system
- Ferrofluid cooled neodymium HF
- Packaged with tile rails and C-ring for quick & easy installation and simple stocking logistics
- Five year warranty

Applications

- Multi-zone foreground music & paging systems
- Boardrooms & offices
- Business music systems
- Airports, convention centres, hotels
- Reception and waiting rooms
- Houses of worship
- Retail outlets and shopping malls
- Lounges and bars
- Cruise ships
- Courtrooms
- Multi-room stereo systems
- Home theatre

Tannoy United Kingdom
 Tannoy North America
 Tannoy Deutschland
 Tannoy France

T: 00 44 (0) 1236 420199
 T: 00 1 (519) 745 1158
 T: 00 49 (180) 1111 881
 T: 00 33 (0)1 7036 7473

E: enquiries@tannoy.com
 E: inquiries@tannoyna.com
 E: anfragen@tannoy.com
 E: ventes@tannoy.com

tannoy®.com



TECHNICAL SPECIFICATIONS

System	CMS401 DCe	
Frequency Response (-3dB) ⁽¹⁾	110Hz - 50kHz	
Frequency Range (-10dB) ⁽¹⁾	80Hz - 54kHz	
System Sensitivity (1W @1m) ⁽²⁾	88dB (1W = 2.83V for 8 Ohms)	
Nominal Coverage Angle	90 degrees conical	
Coverage Angle (1kHz to 6kHz)	123 degrees	
Directivity Factor (Q)	4.6 averaged 1kHz to 6kHz	
Directivity Index (DI)	6.0 averaged 1kHz to 6kHz	
Rated Maximum SPL ⁽²⁾		
Average	106dB	
Peak	112dB	
Power Handling		
Average	60W	
Programme	120W	
Peak	240W	
Recommended Amplifier Power	120W @ 8 Ohms	
Nominal Impedance	8 Ohms	
Transformer Taps (via front rotary switch)		
70V	30W / 15W / 7.5W / 3.75W / OFF & Low Impedance operation	
100V	30W / 15W / 7.5W / OFF & Low Impedance operation	
Distortion		
10% Full Power (6.93V)	2nd Harmonic	3rd Harmonic
250Hz	2.6%	0.5%
1kHz	0.74%	0.53%
10kHz	0.62%	0.10%
1% Full Power (2.2V)	2nd Harmonic	3rd Harmonic
250Hz	0.68%	0.22%
1kHz	0.12%	0.32%
10kHz	0.27%	0.07%
Crossover	2.5kHz - 2nd order LF, 2nd order HF (with dynamic HF protection)	

Transducers	
Low Frequency	1 x 100mm (4.00") Dual Concentric™ constant directivity driver with multi fibre paper pulp cone and point source, constant directivity
High Frequency	19mm (0.75") titanium dome with neodymium magnet system
Physical	
Enclosure	
Back can	Reflex loaded UL 94V-0 rated ABS
Baffle	Reflex loaded UL 94V-0 rated ABS
Grille	Steel, with weather resistant coating
Safety Features	Safety ring located at rear of enclosure for load bearing safety bond
Back Can	Complete with fixed back can
Connectors	Removable locking connector with screw terminals with "loop through" facility
Hole Cutout Diameter	187mm (7.36")
Dimensions	
Bezel diameter	205mm (8.07")
Front of ceiling to rear of pod	147.6mm (5.81")
Net Weight (ea)	2.725kg (6.00lbs)
Included Accessories	C Ring, tile bridge, paint mask, cutout template, grille
Optional Accessories	Plaster (Mud) Ring
Clamping Design	Security toggle clamp
Min / Max Clamping Range	0.0mm (0.0") / 20.0mm (0.79")
Recommended Clamp Torque	1.5Nm

Notes:

- (1) Average over stated bandwidth. Measured at 1 metre on axis.
- (2) Unweighted pink noise input, measured at 1 metre in an anechoic chamber
- (3) Long term power handling capacity as defined in EIA - 426B test

A full range of measurements, performance data, CLF and Ease™ Data can be downloaded from www.tannoy.com

Full independent verification of published specifications carried out by NWAALabs, California can also be obtained from the downloads section of www.tannoy.com

Tannoy operates a policy of continuous research and development. The introduction of new materials or manufacturing methods will always equal or exceed the published specifications, which Tannoy reserves the right to alter without prior notice. Please verify the latest specifications when dealing with critical applications.

Ordering Information

PART NUMBER	MODEL NAME	BAFFLE / GRILLE COLOUR	PACKED QUANTITY
8001 4080	CMS401DCe	White / paintable	2
8001 4180	CMS401 Plaster (Mud) Ring	Zinc plated steel	10

Tannoy United Kingdom
Tannoy North America
Tannoy Deutschland
Tannoy France

T: 00 44 (0) 1236 420199
T: 00 1 (519) 745 1158
T: 00 49 (180) 1111 881
T: 00 33 (0)1 7036 7473

E: enquiries@tannoy.com
E: inquiries@tannoyna.com
E: anfragen@tannoy.com
E: ventes@tannoy.com

tannoy.com



PERFORMANCE MEASUREMENTS

1m on-axis frequency response

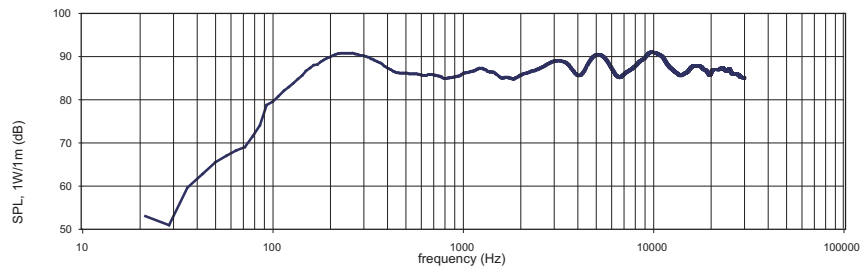

ANECHOIC
FREQUENCY
RESPONSE

Impedance vs frequency

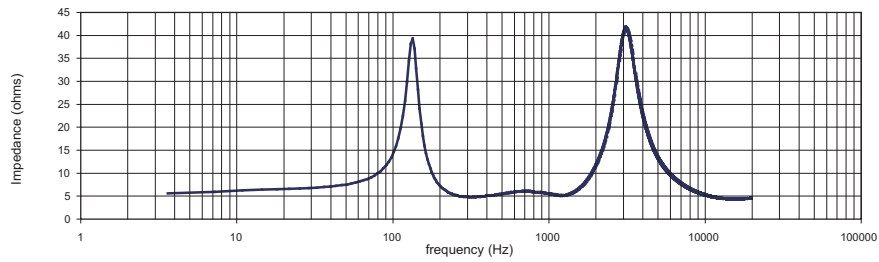

IMPEDANCE

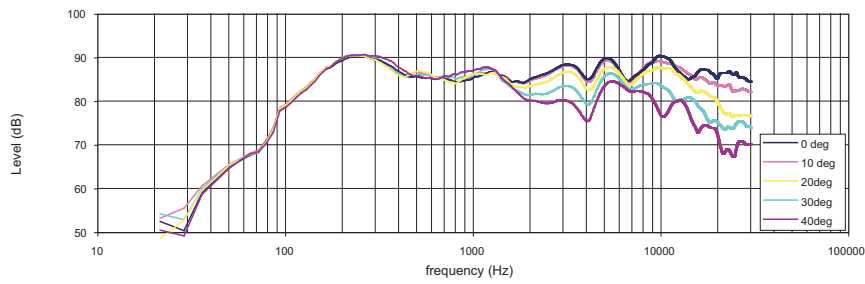

OFF AXIS RESPONSE

Horizontal off-axis response

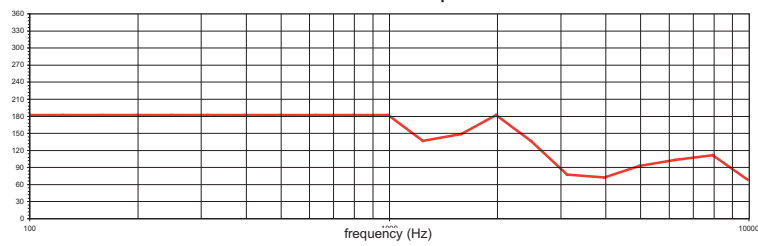

BEAMWIDTH

Horizontal off-axis response

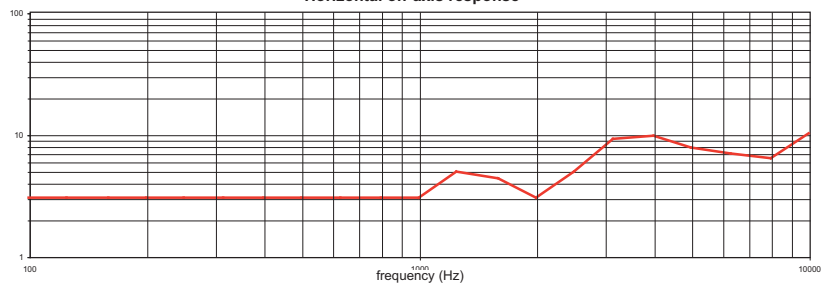

DIRECTIVITY
INDEX

Tannoy United Kingdom
Tannoy North America
Tannoy Deutschland
Tannoy France

T: 00 44 (0) 1236 420199
T: 00 1 (519) 745 1158
T: 00 49 (180) 1111 881
T: 00 33 (0)1 7036 7473

E: enquiries@tannoy.com
E: inquiries@tannoyna.com
E: anfragen@tannoy.com
E: ventes@tannoy.com

tannoy®.com



PERFORMANCE MEASUREMENTS POLAR PLOTS (1/3 OCTAVE)

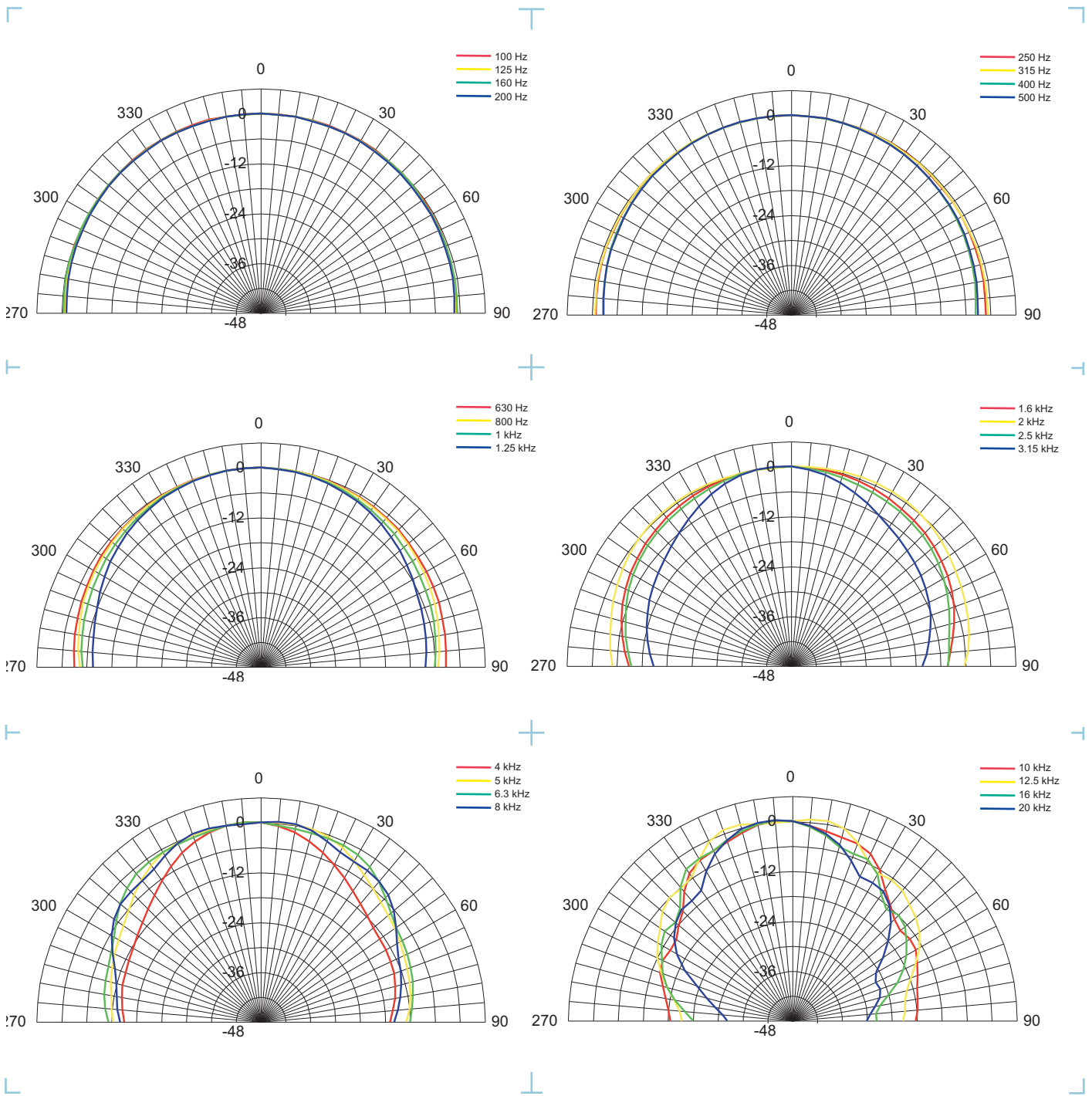

Tannoy United Kingdom
 Tannoy North America
 Tannoy Deutschland
 Tannoy France

T: 00 44 (0) 1236 420199
 T: 00 1 (519) 745 1158
 T: 00 49 (180) 1111 881
 T: 00 33 (0)1 7036 7473

E: enquiries@tannoy.com
 E: inquiries@tannoyna.com
 E: anfragen@tannoy.com
 E: ventes@tannoy.com

tannoy®.com



CMS401 DCe

TANNOY®

DIMENSIONAL SKETCHES

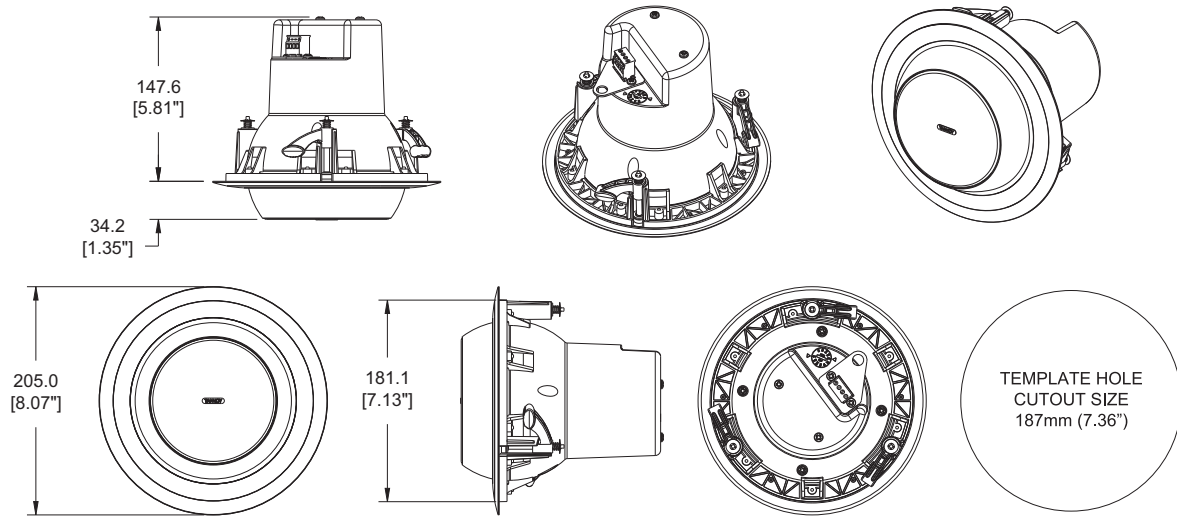

CMS401 DCe TEMPLATE HOLE CUTOUT SIZE - 187mm (7.36")

SUPPLIED ACCESSORIES
C-RING

OPTIONAL ACCESSORIES
PLASTER (MUD) RING

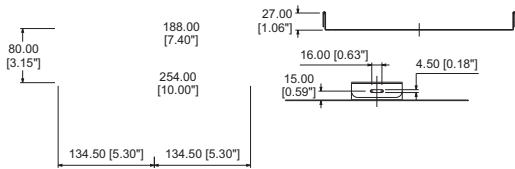

TILE BRIDGE

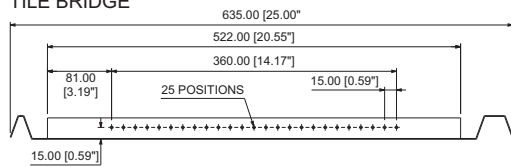

Tannoy United Kingdom
 Tannoy North America
 Tannoy Deutschland
 Tannoy France

T: 00 44 (0) 1236 420199
 T: 00 1 (519) 745 1158
 T: 00 49 (180) 1111 881
 T: 00 33 (0)1 7036 7473

E: enquiries@tannoy.com
 E: inquiries@tannoyna.com
 E: anfragen@tannoy.com
 E: ventes@tannoy.com

tannoy®.com

This job requires more memory than is available in this printer.

Try one or more of the following, and then print again:

For the output format, choose Optimize For Portability.

In the Device Settings page, make sure the Available PostScript Memory is accurate.

Reduce the number of fonts in the document.

Print the document in parts.