

Handbook Contents

- * Safety
- * Installation
- * Facilities
- * Operation
- * Troubleshooting
- * Warranty
- * Technical Details

Box Contents

- 1 x TDS1
- 1 x Power Supply
- 1 x Telephone Lead
- 1 x Handbook



This symbol is used to alert the user to important operating or maintenance instructions.



The Lightning bolt triangle is used to alert the user to the risk of electric shock.

SAFETY

1. It is important to read these instructions and follow them.
2. Keep this instruction manual for reference.
3. Do not operate this unit in a damp environment. It is not waterproof.
4. Refer installation and servicing to qualified personnel.
5. This unit is double insulated and safe to use without an earth connection. The case does not connect to a protective earth unless provided by the screen of the line input XLR connector (pin 1).

INSTALLATION - Please read ALL this Manual before starting

First of all, plan your installation and decide where to fit your TDS1. It needs to be close to a telephone socket, have mains power and an audio signal feed. In MANUAL mode, you will be using a telephone to call the listener, so it may be convenient to install the unit in an ante or side room where no-one will be disturbed by your conversations. The TDS1 generates virtually no heat and so can be installed in any dry, convenient location.

Unpack your TDS1 and check the contents against the list above. As supplied, your TDS1 is set to 100V line input and 3 hour timer enabled.

Telephone Socket

You will need the following to
Get your TDS1 to work:

- Working telephone line
- Audio signal
- Mains power
- Another telephone eg a mobile to test operation.
- Two small screwdrivers, a posidrive to remove the lid and a flat blade to adjust the volume.

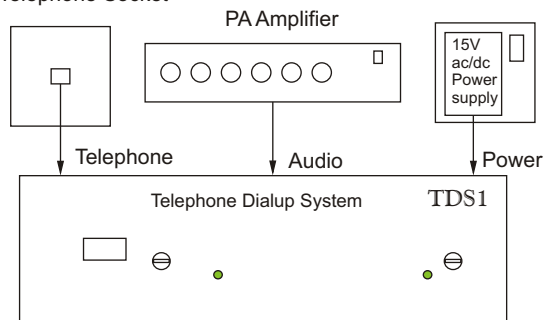

INPUT ATTENUATOR

 Link Out

 Link In

100V Line In J1 J2
 0dB Line In

2V J10
 5V J9
 15V J8
 35V J7
 75V J6
 125V J5

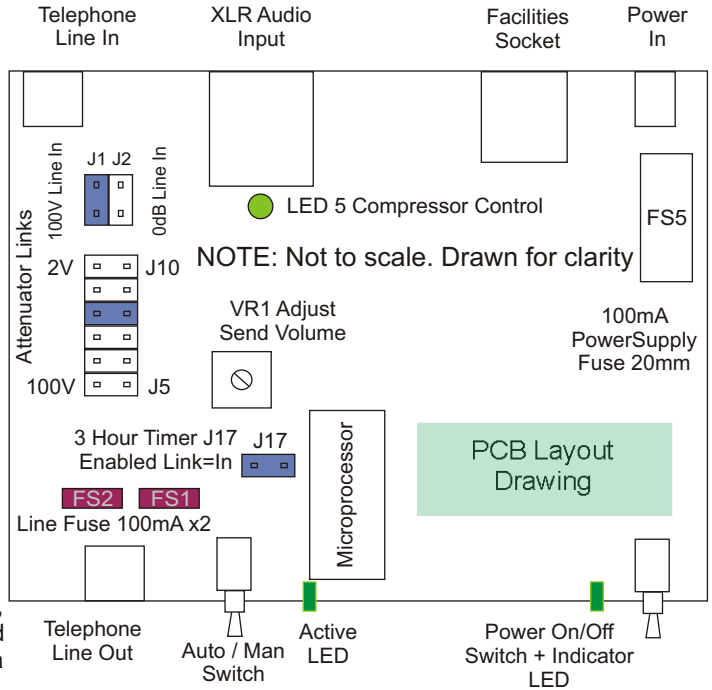

NOTE: Not to scale. Drawn for clarity

As shown in the drawing, the attenuator is selected (J1) and the unit set for a 15V (J8) input signal.

This might be typical of a low impedance loudspeaker where the signal is taken from directly across the loudspeaker. Always start with link in position J5 and move towards J10 to set a sensible volume with the gain control in mid position. LED 5 should flash faintly in sympathy with the input signal.

Audio Inputs

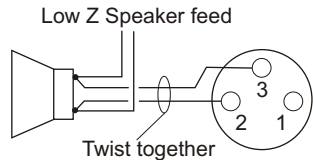
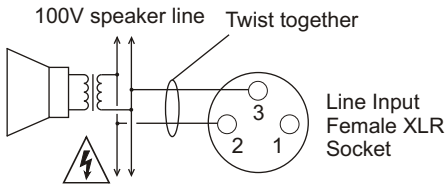

Balanced Line Out

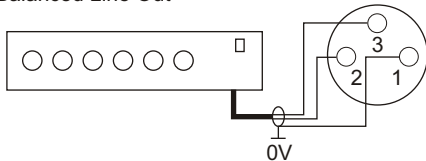

Unbalanced Line Out (Rec Out)

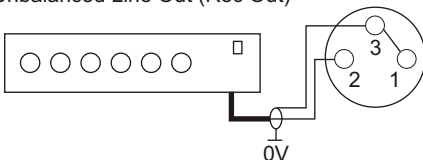

****IMPORTANT****

If using a 100V line signal, you MUST set the attenuator to the highest setting (J1 + J5) BEFORE turning your TDS1 on for the first time. There is a risk of damaging the input circuits if you ignore this advice.

Start by wiring in the audio feed cable and terminate with a male 3 pin XLR plug. Wire the XLR plug according to the type of input signal as shown. Note that pin 1 of the XLR connects to the case of the TDS1 unit and should be grounded at the source end.

The TDS1 has a balanced 3 wire audio input which allows it to work remotely, without electrical interference, even with long lengths of feed cable attached. You can use an unbalanced low level 2 wire feed (eg record out), but keep the feed cable short (<2m) to avoid hum and noise interference. Unbalanced inputs should have pins 1 and 3 connected together and both of these connect to the screen (braid) of the incoming audio feed cable.

The signal source can be any line level signal from 0.5V up to a 100V line speaker feed. Taking the output from the terminals of a loudspeaker will also work, though you will need a much lower attenuator setting (around 15V).

 **WARNING** It is possible to get an electric shock from a 100V speaker line during peak audio output. Switch the PA system off to prevent the risk of electric shock when making connections.

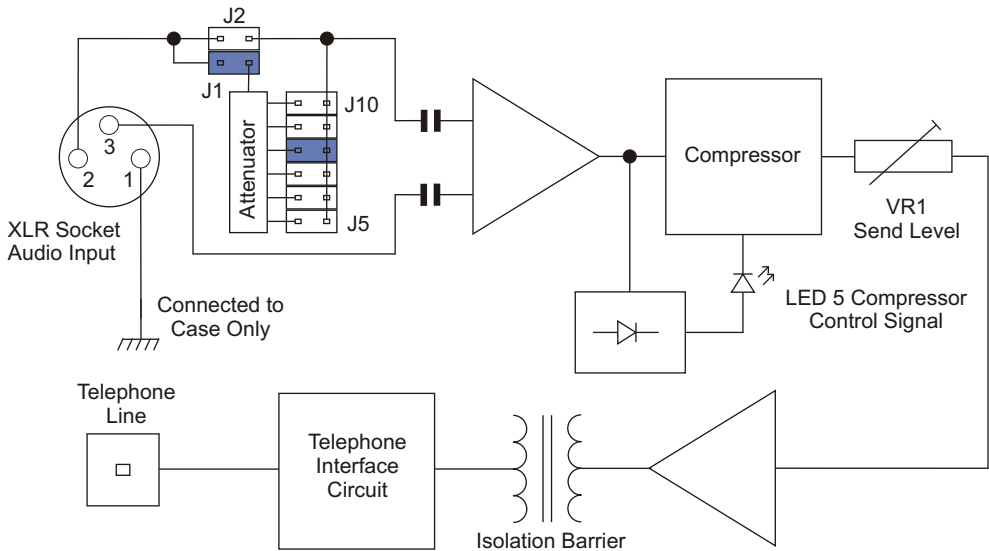

Setting Up

Remove the case lid.

Turn the TDS1 on. Check the green power light illuminates continuously.

Check the Active light flashes, once for AUTOMATIC, twice for MANUAL. This confirms the microprocessor is running.

Play a CD at normal volume over the PA system.

Adjust the attenuator settings until the internal green light (LED 5 immediately behind the input XLR socket) flashes (weakly) in time with the CD audio signal. If the signal is too small, move the attenuator link one position eg from J5 to J6 (or J7 to J8 etc) until the light flashes. With a very small input signal such as a

record output, move link J1 to J2 (this disables the attenuator).

AUTOMATIC Mode

Switch the TDS1 to AUTOMATIC.

Dial the TDS1 telephone line from another telephone. The call should be answered immediately, the Active light should illuminate and you should hear the CD playing.

Adjust VR1 to get the best quality signal. If the sound is distorted or crackles, reduce VR1 until the sound is clear.

You may need to select a different attenuator link (J5-J10) to get the best performance. Some experimentation will quickly determine the optimum settings. Release the call.

The TDS1 should clear down and reset.

Redial the TDS1 telephone line.

The TDS1 should again answer the call and connect to the PA sound.

Release the call.

MANUAL Mode

Plug a telephone into the front of the TDS1 and call the test telephone.

Answer the call.

Briefly move the switch on the TDS1 to the H/R (Hold / Release) position. The Active light should illuminate. You should now hear the PA system through the test telephone and be able to talk to the other telephone as well.

Replace the handset on the telephone plugged into the TDS1 front panel. You can unplug the telephone if you wish.

You should remain connected and be able to hear the PA system through the test telephone.

To end the call, press and hold the switch down to the H/R position for around three seconds or until the Active light extinguishes. Your test telephone should now be disconnected from the PA system.

3 Hour Timer Link

An additional safety feature is available when the TDS1 is used in MANUAL mode. Under normal circumstances, once established, a MANUAL call, held by the TDS1, would remain connected indefinitely. For long meetings, this may be desired. However, for shorter meetings, the possibility exists that the TDS1 operator may forget to disconnect the call and this could be expensive in call charges. By enabling the 3 hour timer link (J17), the TDS1 will automatically release the call after 3 hours.

J17
Link



Link Out - 3 hour timer disabled



Link In - 3 hour timer enabled

J17 can be found to the left of the microprocessor.



NOTE

If power is lost when a call is established, connection will be lost and the calling party must redial.

TDS1 Facilities Output

The facilities socket is for advanced users who want to extend the capabilities of the TDS1. It allows remote AUTO / MAN switching, provides a switch to 0V on connection (remote start) and allows a remote Active light to be used. The remote light can be very useful to indicate the TDS1 is in use and connected.

The remote start (switch to 0V) can be used to start a messaging service or recorded announcement message or even as an on/off switch.

TDS1
Facilities Socket is
a 5 Pin DIN
Connector

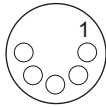

Pin Description	
1	Remote Start
2	Remote LED
3	0V
4	Remote MANual
5	Remote AUTOMatic

Facilities Wiring Diagrams

Close switch to
enable
AUTOMatic
mode

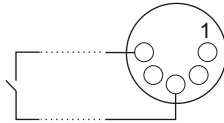

Press switch to
Hold / Release
a MANual call

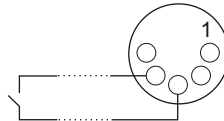

Remote Active
LED

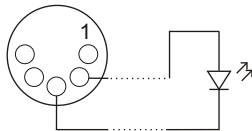

Remote Start
equivalent circuit

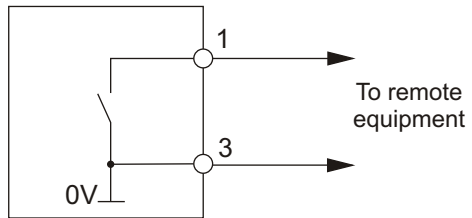

NOTES

Pin 3 (0V connection). To make it easier to connect multiple return wires to pin 3, solder a thick length of wire onto the pin to extend it by 10-15mm. Solder the returns onto this thick wire. Insulate connections to prevent short circuits between pins.

Use a fine tipped soldering iron to make connections. Whilst short circuited connections are unlikely to damage your TDS1, they certainly won't help matters! Check all connections thoroughly and insulate between pins.

Ensure that the switch on the TDS1 is set to MANual if you wish to use remote switching. (Otherwise the remote AUTOMatic mode will not work).

TDS1 OPERATION

Switch the TDS1 on. Note the green power light illuminates and the Active light flashes, one flash for automatic operation, two flashes for manual. This confirms the microprocessor is running. If a remote indicator is fitted, this flashes in sympathy with the Active light. The TDS1 is now ready for use.

MANual mode Put the switch to **Manual**. In this mode, both the Dialup unit and a normal telephone need to be connected to the line. Dial the number of the person nominated to listen in and wait until connected. After establishing connection move the switch from the Manual position to the **H/R** (Hold / Release) position and keep it pressed until the green Active light comes on and you can hear sound from the system. Replace the telephone handset (hang up). The Active light remains on and the called person can hear the program. Press the H/R switch for about 3 seconds at any time to disconnect the Dialup and end the call - green Active light goes out. The call is automatically ended after about 3 hours as a safety precaution though this option can be defeated by moving an internal link.

Note that the TDS1 when set to the **MANual** position and not holding a call, is effectively disconnected and will not answer calls or transmit any audio. This can be useful if confidential meetings are scheduled and it is important not to allow anyone to listen in.

Automatic Mode When set to **AUTO**matic there is nothing to do - the first incoming telephone caller is automatically connected to the sound system and remains connected until they choose to terminate the call. Pressing the H/R switch has no effect and will not release the line. Turn off the power to disconnect the caller if necessary.

General Operating Pointers The sound operator will need to think about his new role in broadcasting the program not only in terms of his local audience, but also those now connected by land line. Unlike a live audience who may be able to half hear even with the microphone turned off, those listening in will hear nothing at all if the sound operator fails to react quickly to someone speaking and this is especially noticeable when using a switch to turn microphones on and off, perhaps missing the first word or sentence even. Like a normal radio station, total silence in the program is highly undesirable and can mislead the listener to think there is a fault in the system perhaps even causing them to hang up and end the call by mistake. To avoid this, the sound operator must always be transmitting something even a small amount of background noise (chatter) will help. This is especially important before and after the meeting as well as in between program items. Even during the singing of songs, a small amount of audio via a half opened microphone (not the one next to the chairman please!) will greatly enhance the program output to those listening in and make them feel totally involved. Thought is required by the sound operator as to what is being heard by the listeners. His efforts in this regard will be highly valued by the callers.

Multiple callers may be able to listen on each telephone line by using the 'three way caller' option. Results for this service can be very patchy and depend upon a number of factors, but it is worth trying. Some users routinely connect four different locations via two telephone lines. If each caller also has a three way option, even more callers could be connected though this is unproven. (Please feedback any results on this to us). Anyone using the service is well advised to buy a modern loudspeaking telephone which has a mute feature. This cuts off the internal microphone on the telephone and can make the sound even clearer especially if multiple users are connected on each line. If the telephone is placed on a hard surface then the volume will be found adequate for a room

with three or four people in it. For larger venues or locations where the volume is not adequate i.e. many miles from the serving telephone exchange, use a handset with jack audio output. This allows connection from the telephone line into a line input (i.e. CD) on a hi-fi system and hence the signal can be adjusted for loudness and quality by using the volume and tone controls. Of course this could also be used in remote areas for tying halls together when for example the public speaker is unable to get to the venue for whatever reason or even for memorial overflow situations.

The TDS1 Dialup Unit is microprocessor controlled and makes use of surface mount technology to achieve small size together with high reliability. There are no moving parts to wear out and all components are conservatively rated to give a long service life.

These instructions are written to help you get the best from your Dialup unit but they need to be followed closely especially by the sound operator if you are to achieve this. For best possible results, invest in an automatic microphone mixer to avoid missing the first word or even sentence of any comments, as this is highly frustrating to Dialup users.

TROUBLESHOOTING See www.dt4u.com for latest information

- | | | |
|---|---------------|---|
| 1 | No Power | Make sure the power supply is plugged in and the mains socket live. Ensure that the TDS1 is switched on. If the green power light is unlit, unplug the power supply and check the fuse (FS5) is not blown. If it is, replace by a 100mA 20mm fuse. Do NOT replace with a larger fuse or permanent damage will be caused. |
| 2 | Cuts Off | Do not try to send too loud a signal down the telephone line otherwise this will be interpreted by the microprocessor as a disconnect signal. If the received sound crackles or cuts off, reduce the output level (VR1) until a clear sound is received. If you have been connected for around three hours and then the TDS1 cuts off, check that the three hour timer link (J17) is disabled (out). |
| 3 | Too Quiet | There is a limit to how loud the signal is that can be sent down a telephone line. If the received sound is too quiet, the user will need an amplified telephone or better, a hands free telephone with volume control. Some models are louder than others so ask for a demonstration. |
| 4 | No Connection | The TDS1 seems to be working in MANual mode but won't answer calls in AUTOMATIC. Check that the telephone line works and that you are dialing the right number. Plug an ordinary telephone into the line jack and test the line. If you can make and receive calls, check the telephone lead between TDS1 and telephone socket. There are two telephone line fuses within the TDS1. Disconnect the telephone line and test FS1 and FS2. |
| 5 | No Audio | Check all the audio wiring for continuity. Ensure the audio signal is applied between XLR pins 2 and 3. |
| 6 | Storm | There was a storm and now the TDS1 does not work. Return to base for repair and check. |
| 7 | Erratic | After connecting the facilities wiring, the TDS1 becomes unreliable. Could be faulty wiring (intermittent joints or short circuits). Or the wiring could run close to a source of electrical interference eg thyrister lighting - re-route the cable. |
| 8 | Remote | Remote LED doesn't work - Reverse the connections. |

WARRANTY

The TDS1 is guaranteed for a period of 1 year from the date of purchase provided that it has been used in accordance with all these instructions. This warranty specifically does NOT cover damage by lightning or user abuse and is on condition that the unit is returned by prior agreement, to the supplier. Repair or replacement is at the discretion of the supplier under the terms of this warranty.

In the unlikely event that your TDS1 fails, please contact the supplier for a return address. When returning a unit, use the original packaging, be sure to include a return address and contact point, and include a brief description of the problem. We will provide a repair estimate if asked in advance.

TECHNICAL DETAILS

Power:	15V AC/DC 100mA
Fuses:	1 x 20mm 100mA Power 2 x 100mA Boxed Line
Audio:	0.5V - 100V input
Remote Start	Capable of switching 80mA to 0V
Remote LED	5V output via 470Ω Resistor
REN:	1.0
Approvals:	CE approved
DOC	Declaration Of Conformity - Available on request

ACCESSORIES

Available to special order and at additional cost for this product - see www.dt4u.com for more details.

OVERVIEW

The TDS1 (Telephone Dialup System - 1 line) was originally designed to allow anyone to dial into a sound system and listen live to the program audio feed. In the AUTOMATIC mode, the TDS will answer the first incoming telephone call and connect the caller to the audio. In the MANUAL mode, calls can be established and controlled from the TDS unit. The facilities connector allows access to various switching and output signals and can be used to operate remote equipment, generate alarms or give visual indication of status.

This makes the TDS unit valuable for many applications ranging from:

- * Remote monitoring of audio signals such as transmitter sites.
- * Live monitoring of a sound system.
- * Messaging services.
- * Audio program hookups.
- * Remote switching.